



## Model IEP-1520

### Wall Fixed Electric Room Heater INDOOR USE ONLY

# INSTALLATION / OWNER'S MANUAL



#### WARNING

Read all instructions before using this heater.

Read and understand all installation and maintenance instructions thoroughly before installing or servicing this equipment.

Improper installation, operation, adjustment, alteration, service or maintenance can result in the risk of fire and electrical shock, and may cause property damage, injury or death.

#### SAFETY ALERT:



This heater must be serviced only by a qualified electrician. Failure to comply could result in personal injury, death, fire and/or property damage.

Do not operate this heater unless it is properly installed.



Always disconnect the heater from the power source prior to servicing.

Do not store or use gasoline or other flammable vapours and liquids in the vicinity of this or any other hot surface appliance.

**INDOOR USE ONLY - Do not use this heater outdoors**



Do not use or locate this model where it could fall into a bathtub or other water container.

Do not cover or block any surface of this appliance.

Do not touch this appliance while in operation

- Allow to cool after use.



Read the **IMPORTANT INFORMATION** section of this manual before using this appliance.

## SAVE THESE INSTRUCTIONS



Intertek  
3154365

Conforms to ANSI/UL 2021  
Certified to CAN/CSA C22.2 No.46

**INSTALLER: PRESENT THIS MANUAL TO THE END USER. Keep this manual in a secure place.**

Record the following information for future reference if service is required:

Model #: **IEP-1520**

Serial #: \_\_\_\_\_ (located on heater rating label)

**NOTICE:**

*This contents of this manual are current for this product at the date of manufacture. Occasional revision of the product Certification Standard may require changes to the product and/or the content in the product manual. The product must be installed according to the content of this manual, and/or all local and national code requirements.*

*This publication is the intellectual property of Schwank. This publication, or parts thereof, may not be reproduced in any form, without prior written consent from The Manufacturer. Unauthorized use or distribution of this publication is strictly prohibited.*

**Schwank Group**

Schwank and InfraSave brands

*5285 Bradco Boulevard*

*Mississauga, Ontario, L4W 2A6*

*2 Schwank Way*

*Waynesboro, Georgia 30830*

**Customer & Technical Services**

*Phone: 877-446-3727*

*Fax: 866-361-0523*

*e-mail: [csr@schwankgroup.com](mailto:csr@schwankgroup.com)*

**[www.schwankgroup.com](http://www.schwankgroup.com)**

**[www.infrasave.com](http://www.infrasave.com)**

# IEP 1520

## Wall Fixed Electric Room Heater For INDOOR USE ONLY

### Table of Contents

1. IMPORTANT INSTRUCTIONS: .....	4	<b><i>Read First !!</i></b>
2. Heater Dimensions, Wiring, Specifications .....	6	
3. Project Design Considerations & Guidelines .....	7	
4. Installation Instructions:		
General Information .....	9	
Locating the Heater .....	9	
Minimum Required Clearances .....	10	
Heater Mounting.....	10	
5. Operating Instructions.....	12	
6. Grounding.....	12	
7. Maintenance Instructions .....	13	
8. Cleaning.....	13	
9. Heater Parts.....	14	
10. Heat Lamp Replacement .....	15	
11. Warranty Statement.....	18	
FIGURE 1: Minimum Required Clearances .....	7	
FIGURE 2: Mounting Bracket .....	8	
FIGURE 3: Heater Bracket .....	8	
FIGURE 4: Grounded Electrical Connection.....	9	
FIGURE 5: Heater Parts .....	11	



# 1. IMPORTANT INSTRUCTIONS

When using electrical appliances, basic precautions should always be followed to reduce the risk of fire, electric shock, injury to persons or death, and property damage including the following :

1. **Read all instructions before using this heater.**
2. **CAUTION: HIGH TEMPERATURE - RISK OF FIRE.** Keep electrical cords, and combustible materials, such as furniture, pillows, bedding, papers, clothes, and curtains at least 3 feet (36 inches) [90 cm] from the front of the heater and keep them away from the sides and rear.
3. This heater is hot when in use. To avoid burns, do not let bare skin touch hot surfaces.
4. Extreme caution is necessary when any heater is used by or near children or infirm persons. Always supervise children and instruct and ensure that they do not play with the heater.
5. Always unplug heater when not in use. Never leave the heater unattended during operation.
6. Do not operate any heater with a damaged cord or plug or after the heater malfunctions, has been dropped or damaged in any manner. Return heater to an authorized service facility for examination, electrical or mechanical adjustment, or repair.
7. Do not use outdoors or in wet environments.
8. This heater is not intended for use in bathrooms, laundry areas, and similar indoor locations. Never locate heater where it may fall into a bathtub or other water container.
9. Do not run cord under carpeting. Do not cover cord with throw rugs, runners, or the like. Arrange cord away from traffic areas where it will not be tripped over.
10. Arrange the cord at the side and back of the heater - do not allow cord to drape over the heater.
11. To disconnect heater, turn controls to off, then remove plug from outlet.
12. Only connect the heater to a 115 - 120Vac outlet that is properly grounded. Ensure the electrical outlet is readily accessible to be able to disconnect the heater when needed.
13. Do not insert or allow foreign objects to enter the heater or any ventilation

*continued ...*



## IMPORTANT INSTRUCTIONS *continued*

or exhaust opening as this may cause an electric shock, fire, or damage the heater - death, personal injury or property damage could result.



14. To prevent a possible fire, do not block air intakes or exhaust in any manner. Do not use on a soft surface, like a bed, where openings may become blocked.



15. To reduce the risk of fire - Do not store or use gasoline, paint, or other flammable liquids or vapors in the vicinity of the heater.

16. Use this heater only as described in this manual. Any other use not recommended by the manufacturer may cause fire, electric shock, and death or injury to persons and property damage.

17. Avoid the use of an extension cord because the extension cord may overheat and cause a risk of fire. *IMPORTANT:* However, if you have to use an extension cord, the cord shall be No. 14 AWG minimum size and rated not less than 1875 watts.



18. Do not touch an operating heater or live parts - burns, electric shock and death or personal injury can result.

19. Do not adjust the heater on the swivel bracket during operation. Allow heater to cool before making any adjustment to heater position.

20. Do not stare at the heater Lamp - damage to your eyes could occur.

21. After use, allow the heater to cool down before moving or storing.

22. These instructions belong with the heater for ready reference. Keep this manual in a safe place near the heater.

23. **“SAVE THESE INSTRUCTIONS”**

## 2. HEATER DIMENSIONS, WIRING, SPECIFICATIONS - IEP 1520

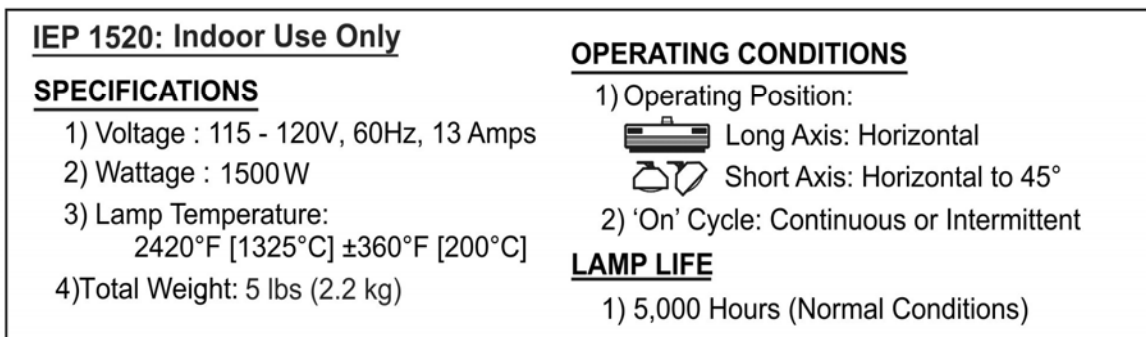
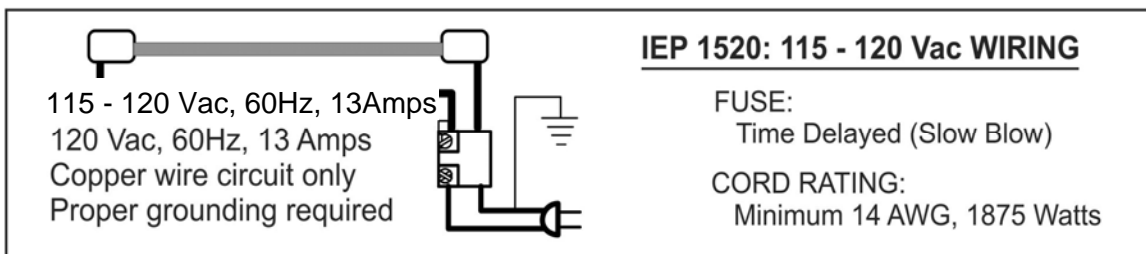
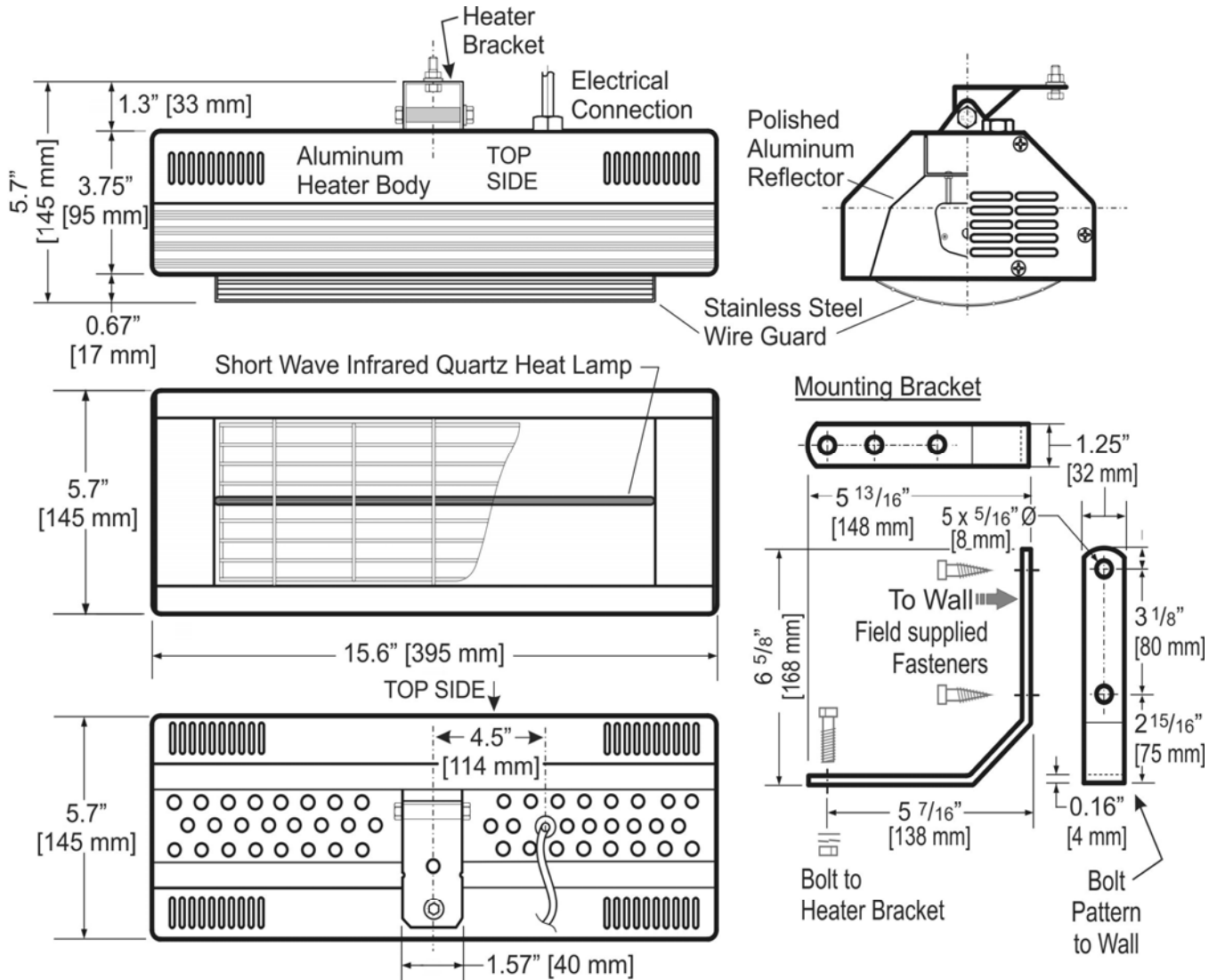

### 3. PROJECT DESIGN CONSIDERATIONS & GUIDELINES:

**NOTE: Also refer to Section 4. Installation, and Table 2 and Figure 2 regarding the Minimum Required Clearances.**

The size and quantity of heaters (amount of heat input) required over an area to provide comfort is affected by the following factors:

- General:
  - Amount of air movement in the area: “wind chill” requires additional heat input
    - Provide wind breaks wherever possible
  - ‘Spot heating’ comfort is most effective if people are heated from at least two sides
  - Available mounting height for heaters at the project site
- Indoor application:
  - ‘Space heat’ the entire structure<sup>1</sup> (accurate heat loss calculation required), *or*
  - ‘Spot heat’ only part of a cold indoor area
  - The activity level of the people: seated at rest, hard physical labor, etc.
- Outdoor application: *Any area heated outdoors is ‘Spot heat’*
  - **NOTE: Model IEP 1520 is for INDOOR USE ONLY**
  - Ensure that the heater model is suitable and approved for outdoor use
- Desired temperature rise:
  - What is the coldest ambient air temperature that the design must consider?
  - Then what comfort temperature rise is desired? (Indoor to 65°?) (Outdoor to ...?)
- Calculate the required input to get the desired average temperature rise:

Input Required per Area per Degree Comfort Temperature Rise

	Heat Density per Degree F $\frac{w}{(ft^2)/F^\circ}$	Heat Density per Degree C $\frac{w}{(m^2)/C^\circ}$	
Outdoor Heating	2	40	<i>Up to 10 mph wind</i>
Indoor Spot Heat	0.75	14	<i>Protected area - low air movement</i>

- ◇ Input = Site Length x Site Width x Temperature Rise x Heat Density per Degree
- ◇ Example: (*use a heater approved for Outdoor use for outdoor applications*)
  - Outdoor Patio: 30 ft long by 10 feet wide
  - Desired temperature rise: 20°F (*average over the area*)
  - 30 x 10 x 20 x 2 = 12,000 Watts total input required
- Compare the values of the available mounting height and area dimensions at the project site to the recommended mounting heights, length and width of coverage area, and typical average heat distribution in Figure 1 & Table 1 (next page)
- Layout:
  - Space the heaters uniformly around the perimeter (and if required, in the center or throughout the area) to provide sufficient heat density to accomplish the desired temperature rise *or* spot heat only specific locations within the area
  - Provide heat from at least two sides wherever possible

<sup>1</sup> Contact Schwank Design Services for assistance at [design@schwankgroup.com](mailto:design@schwankgroup.com).

The design information presented here is intended as a guideline. The accuracy of determining or estimating all factors above will affect performance and satisfaction. Air movement in particular affects creature comfort.

**FIGURE 1: RECOMMENDED MOUNTING: COMFORT AREA COVERAGE**

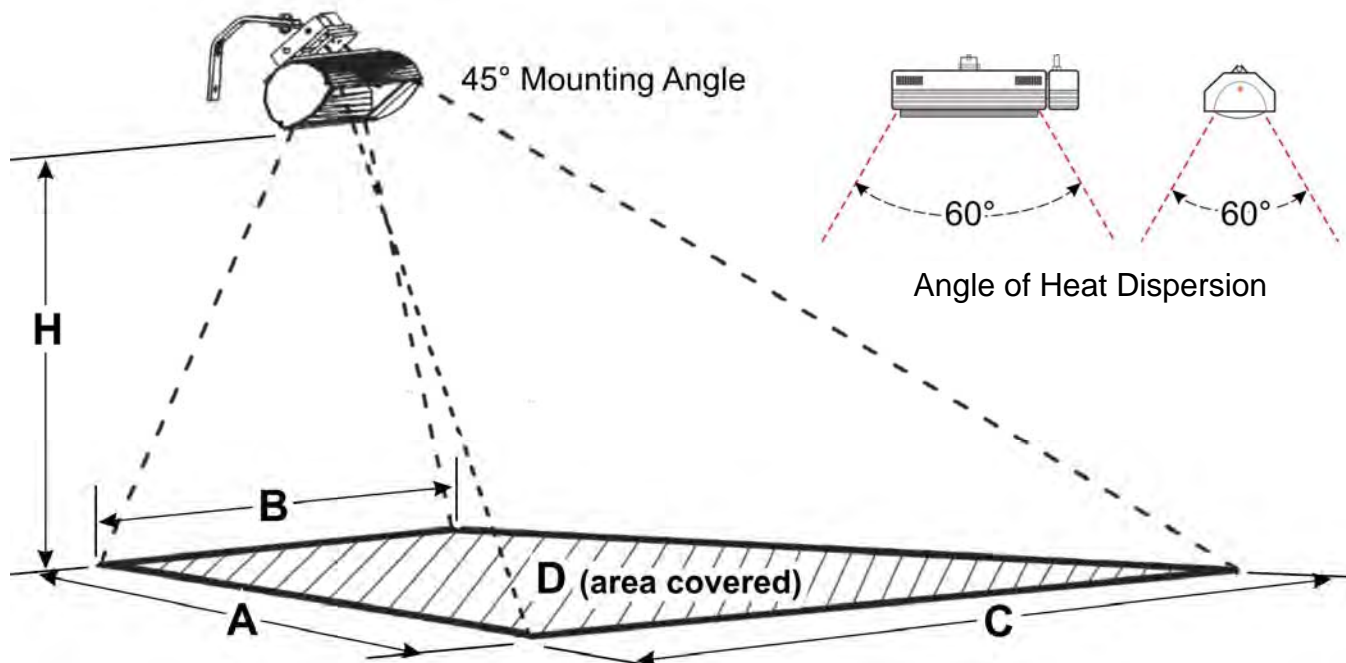

**TABLE 1: RECOMMENDED MOUNTING FOR SAFETY AND COMFORT AREA COVERAGE**

Model	Input Watts	Min / Max	H Height Above Floor/Deck ft [m]	A Distance Out ft [m]	B Under Heater ft [m]	C Outer Perimeter ft [m]	D Heated Area ft <sup>2</sup> [m <sup>2</sup> ]	E Average Heat Density watts / ft <sup>2</sup>
IEP 1520/4	1500	Min.	7 [2.1]	8.8 [2.7]	8.5 [2.6]	16 [4.9]	108 [10.1]	13.9
		Max.	8 [2.4]	9.8 [3.0]	9.2 [2.8]	18 [5.5]	133 [12.4]	11.3
IEP 2024	2000	Min.	8 [2.4]	9.8 [3.0]	9.2 [2.8]	18 [5.5]	133 [12.4]	15.0
		Max.	9 [2.7]	11 [3.4]	10 [3.0]	20 [6.1]	165 [15.3]	12.1
IEP 4024	4000	Min.	10 [3.0]	12 [3.6]	11.2 [3.4]	23 [7.0]	205 [19.0]	19.5
		Max.	11.5 [3.5]	13.5 [4.1]	14 [4.3]	27.5 [8.4]	275 [25.4]	14.5
IEP 6024	6000	Min.	12 [3.7]	14 [4.3]	15 [4.6]	29.5 [9.0]	315 [29.2]	19.0
		Max.	15 [4.6]	14.4 [4.4]	17.7 [5.4]	32 [9.8]	360 [33.4]	16.7

- Refer to design guidelines on previous page.
- Refer to Required Minimum Clearances: Table 2 & Figure 2, Page 10



## 4. INSTALLATION INSTRUCTIONS

### **General: READ ALL INSTRUCTIONS AND PLAN THE INSTALLATION BEFORE PROCEEDING**

This appliance conforms to ANSI/UL 2021 and is certified to CAN/CSA C22.2 No.46. This appliance is approved for indoor use only. Do not use this heater outdoors or in wet environments such as bathrooms and laundry rooms.

The heater is supplied with an 8 ft [2.4 m] cord with a three prong plug that must connect to a properly grounded 115 - 120 Vac outlet on a copper wire electrical supply circuit.

A mounting bracket is supplied with the heater, and can be mounted to a wall or post. The heater must be mounted to this bracket during operation. Hardware to fasten the mounting bracket to the structure is determined by site conditions, and is field supplied by the installer.



**IMPORTANT:** Always maintain the minimum clearances from the floor, ceiling, side walls, and combustible materials. Refer to Table 2 and Figure 2 next page.



**IMPORTANT:** Avoid the use of an extension cord because the extension cord may overheat and cause a risk of fire. However, if you must use an extension cord, the cord shall be **No. 14 AWG** minimum size and **rated not less than 1875 watts**.

### **Locating the Heater:**

**Warning:** Use of this heater in coastal salt-air regions can result in corrosion of the aluminum body and reflector, and premature failure the heat lamp. Corrosion and failure resulting from use in coastal areas represents normal use in that environment and is not covered by warranty.

1. The heater is designed for wall or post mounting and operation with plug-in cord (8 ft [2.4 m]) connection and must be installed at least 6 feet (1.8 m) above the floor.
2. Ensure that clearances from the heater meet or exceed the minimum required clearances in Table 2, and Figure 2 below: Above; to the Floor; to a Side wall; and to Combustible materials.
3. The heater must plug in to a properly grounded 115 - 120 Vac outlet. Ensure the electrical outlet is readily accessible to be able to disconnect the heater when needed.
4. The heater should never be placed nor mounted directly under a wall electrical outlet.
5. A minimum distance of 3 ft (36 inches) [90 cm] must be maintained between the front grille and flammable items (e.g. curtains), walls and other structures.
6. Do not allow the electrical cord to pass in front of the heater or to touch any hot surface.
7. The appliance must not be mounted directly on flammable materials (no wood or similar).
8. Do not expose the heater to rain or other moisture.
9. Since the appliance radiates heat, no obstruction or object such as furniture should be placed between the heater and the person being heated.

*continued ...*

**TABLE 2: MINIMUM REQUIRED CLEARANCES**

<b>IEP 1520</b>	<b>Above 'A'</b> Inches [cm]	<b>Floor 'F'</b> Inches [cm]	<b>Clearance 'C'</b> Inches [cm]	<b>Spacing 'D'</b> Inches [cm]
1500 W, 115-120V, 60 Hz, 13 Amps	12" [30]	72" [180]	36" [90]	More than 36" [90]

**FIGURE 2: MINIMUM Required Clearances**

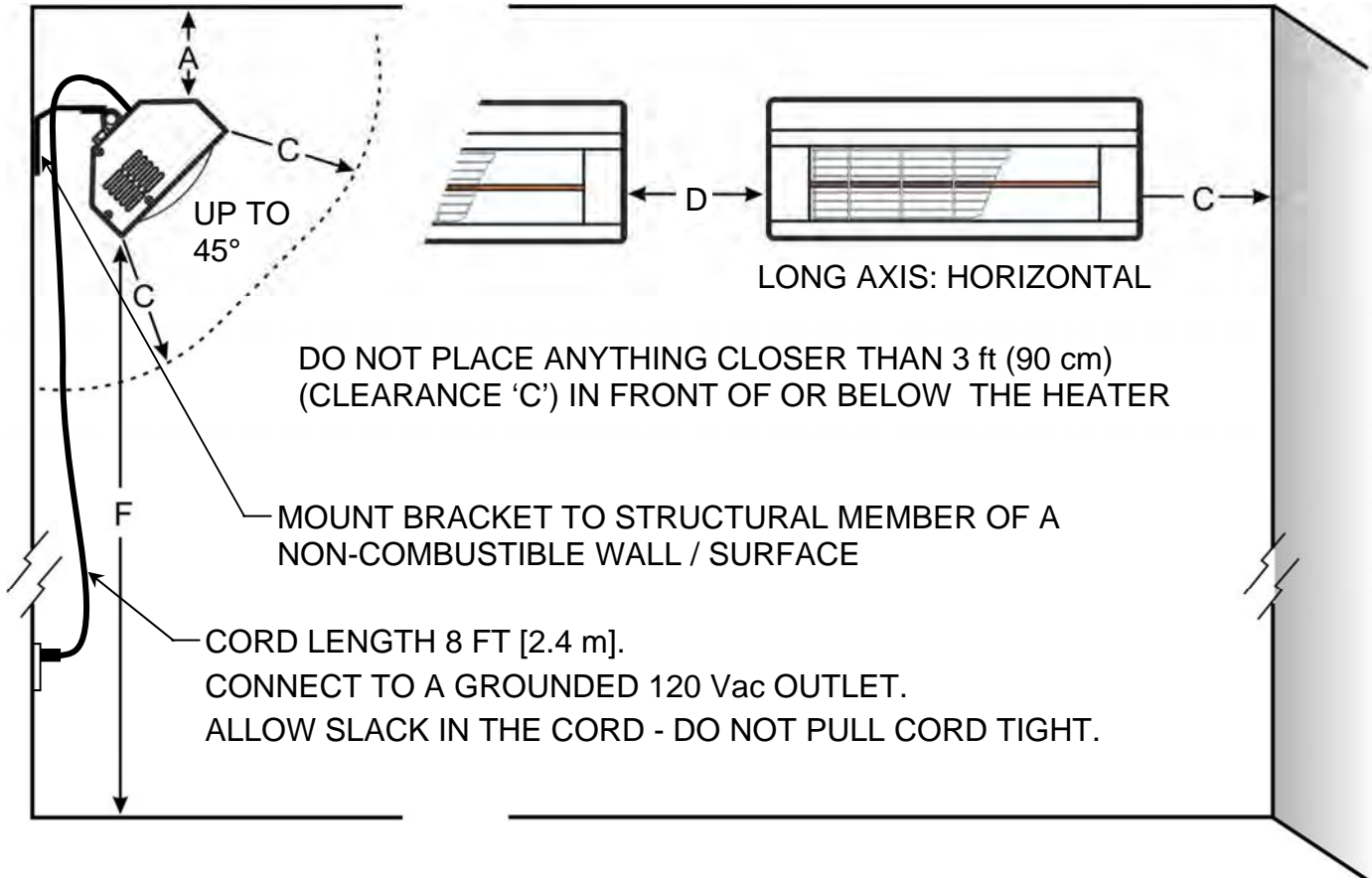

10. Do not use heater on a soft surface, like a bed, where air openings may become blocked.
11. A heater has hot surfaces and potentially arcing or sparking parts inside. Do not use in areas where gasoline, paint, or flammable vapors or liquids are used or stored.

### **Heater Mounting:**

1. Mount the heater on a non-combustible surface or structural member, and maintain at least all minimum clearances indicated in Table 2 and Figure 2 above.
2. Use the Mounting Bracket supplied with the heater - see Figure 3 next page.
3. Hardware to fasten the Mounting Bracket to the structure is field supplied by the installer since the type of hardware fastening is determined by site conditions.
4. If at all possible, locate the mounting bracket so that the electrical cord (8 ft [2.4 m]) can be plugged into an electrical outlet (grounded 115 - 120 Vac) without stretching the electrical cord taught. See important notice (previous page) regarding the use of

*continued ...*

**FIGURE 3: MOUNTING BRACKET**

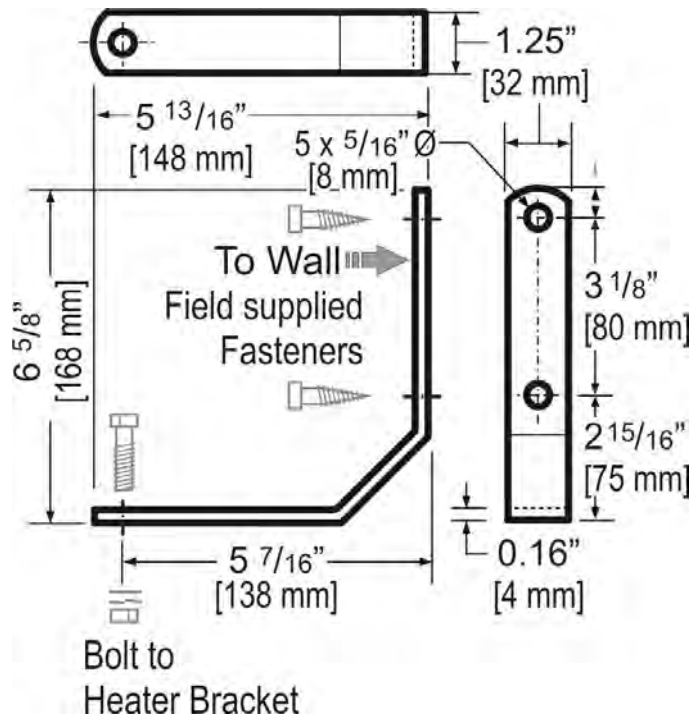

**FIGURE 4:  
END VIEW WITH  
HEATER BRACKET**

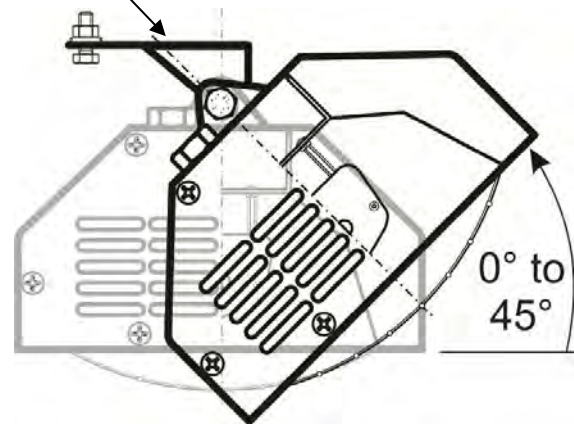

an extension cord.

5. Never allow the electrical cord to pass in front of the heater or to come into contact with any hot surface of the heater.
6. The Mounting Bracket fastens to the structure using field supplied bolts or lag screws through two holes in one side of the bracket. The heater bracket fastens to the Mounting Bracket through the outermost hole on the other leg of the Mounting Bracket, using the bolt, lock washer and nut supplied.
7. Fasten the Mounting Bracket 'plumb' and level so that the heater is oriented horizontally on the long axis.
8. Ensure that the mounting bracket is firmly fastened to the structure with bolts or lag screws (field supplied) of sufficient strength and integrity to support the weight and prevent movement of the heater. It is recommended to fasten the mounting bracket to a structural member (wall stud, etc.).
9. Attach the heater bracket to the Mounting Bracket (outermost hole), using the bolt, lock washer and nut supplied - tighten securely.
10. The bracket attached to the top of the heater allows rotation up to 45° on the short axis by loosening the attachment bolt.
11. Once heater position is established, tighten all nuts and bolts at mounting and heater bracket connections to maintain the heater in a secure and stable position.
12. Read and follow all warnings, and the following section on Operation to enjoy safe operation of the heater.

## 5. OPERATING INSTRUCTIONS

1. The heater must be properly installed prior to use.
2. Always ensure the heater is located at a safe distance from the floor, ceiling, side walls, and combustible materials - refer to Table 2 and Figure 2.
3. Maintain a minimum distance of 36 inches [90 cm] from heater to combustible material.
4. Always be aware and careful of the risk of fire and electric shock.
5. The power cord must not come into contact with hot appliance parts or surfaces and must not pass in front of the heater.
6. Never pull the plug out of the outlet using the cord. Grasp the plug directly to remove.
7. Never move the appliance by pulling at the cord or use the cord for carrying purposes.
8. Do not coil the cord around the appliance.
9. Do not use the appliance with the cord coiled.
10. Do not crush the cord, nor drag it over sharp edges, nor place it over a heated hotplate or open flame.
11. Read, understand, and explain and describe to other users the location, function, and operation of each control of the heater, including all user-operated devices intended to reduce the risk of fire, electric shock, or injury to persons and warn against tampering with such.
12. Connect the heater only to a grounded 115 - 120 Vac outlet. A time delayed fuse may be necessary for circuit protection.
13. If the supply cord is damaged, it must be replaced by a qualified electrician in order to avoid a hazard.
14. High heat is generated from the front of the heater.
15. Do not allow children to touch or play with the heater.
16. Do not use the heater to dry wet materials or clothing.

## 6. GROUNDING

This heater must be connected only to a properly grounded 115 - 120 Volt AC power outlet. The cord has a 3 pronged plug as shown below in Figure 5.

If you do not have a grounded power outlet, DO NOT REMOVE the ground pin from the plug - have a qualified electrician install a properly grounded outlet.

**FIGURE 5: GROUNDED 115 - 120 Vac ELECTRICAL CONNECTION**

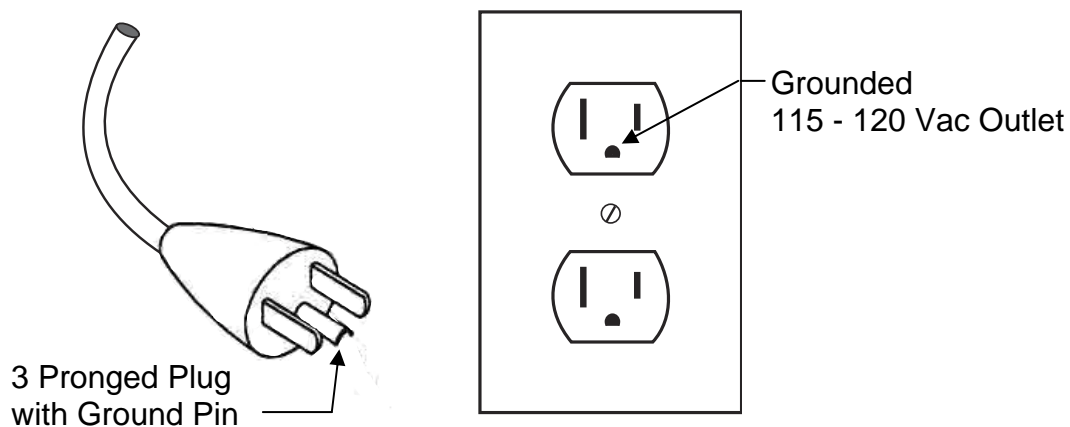

## **7. MAINTENANCE INSTRUCTIONS**



### **WARNING**

Heater service should only be performed by a qualified electrician. Failure to comply could result in personal injury, death, fire and/or property damage.

Tampering with the heater by an unqualified person will void the warranty.



### **WARNING**

Always unplug or disconnect the heater from the electrical power supply prior to any cleaning, maintenance or service work.

Never immerse the appliance in water! Danger to life!



**CAUTION:** The Heat Lamp is fragile. Handle the heater with care so as not to damage the Heat Lamp. Never touch the Lamp with bare fingers. Oils from your skin will damage the Lamp.

### **Inspect the heater and cord prior to each use:**

- Clean any accumulation of dust or dirt from surfaces and in particular from the reflector and any air openings in the heater body (refer to Cleaning section below).
- Any damaged parts or components must be repaired or replaced prior to operation.

### **Service and Repair:**

- Disconnect the heater from the power source prior to servicing
- Important: All repairs must be referred to qualified electrician!
- Repairs carried out improperly or by an unqualified person may have serious consequences for the user!
- Any tampering with the appliance will invalidate the warranty.

## **8. CLEANING**

- Before cleaning - Disconnect the heater from the power supply and allow to cool.
- Do not touch the Heat Lamp with your fingers - oil from your skin will damage the Lamp.
- To clean the heater surface, reflector, and air inlets: Use only a dry or damp cloth or low pressure air stream (computer 'duster' in a can).
- Do not use any abrasive or caustic cleaning agents.
- Never immerse the appliance in water! Danger to life!
- If a heater is exposed to water have a qualified electrician inspect and repair the heater prior to use.
- Inspect the electrical cord and plug for damage or fraying.
  - Do not operate the heater with a damaged cord or plug.
  - Have damaged parts replaced by a qualified electrician

## 9. HEATER PARTS

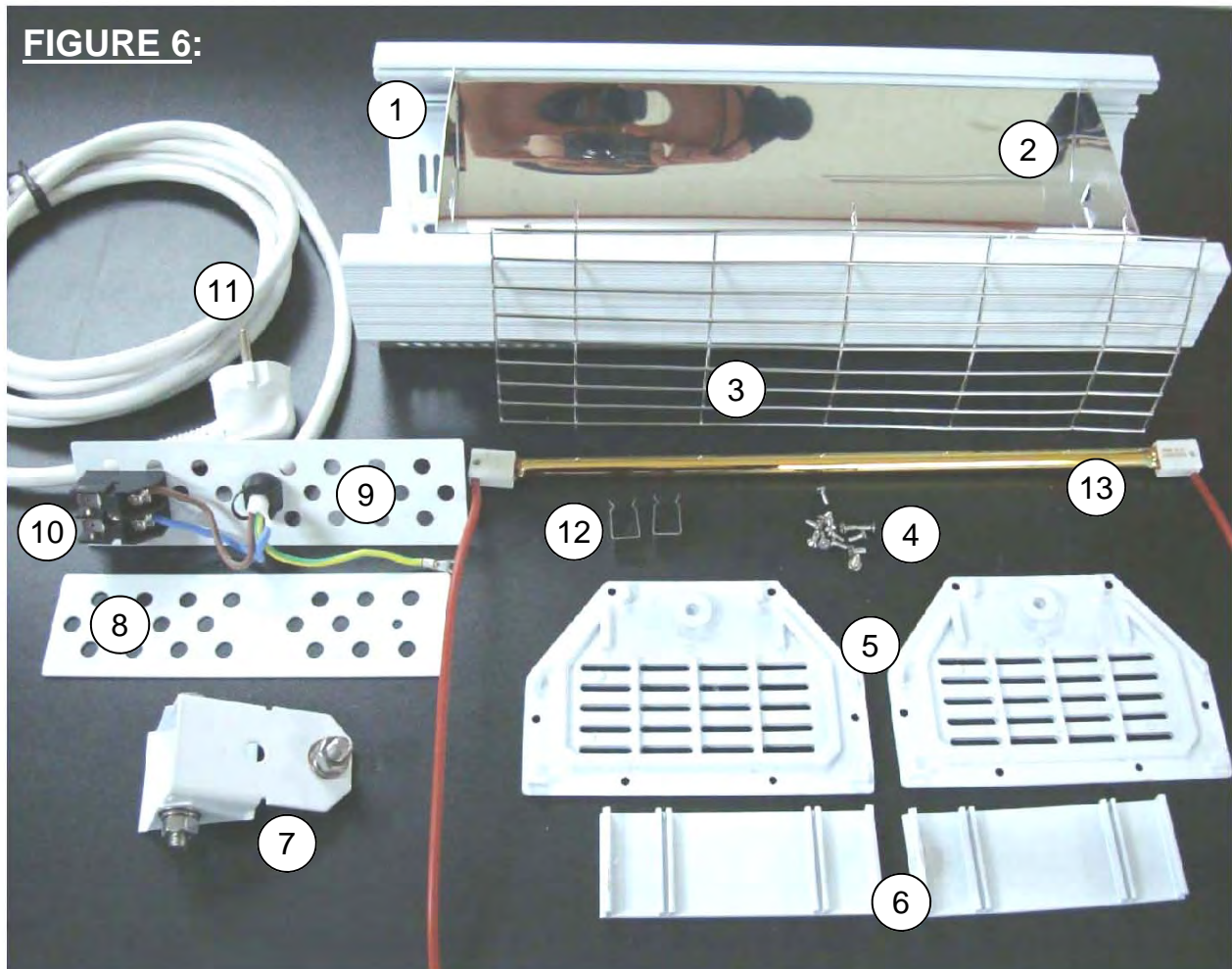

1. Heater Body - cast aluminum
2. Polished Aluminum Reflector Assembly
3. Protective Screen
4. Assembly Screws
5. End Covers
6. Face Plates
7. Heater Mounting Bracket
8. Center Cover Plate (top side)
9. Power Cord Retainer Plate
10. Terminal Block for electrical connections
11. Power Cord with factory assembled 3 Pronged Plug
12. Lamp Retainer Clips
13. Heat Lamp - 1500 Watts - Part # JE-1500-XX

*NOTE: Heater is shown with white finish for clarity in photograph. Actual heater has black finish.*



## 10. HEAT LAMP REPLACEMENT

The Heat Lamp will operate for approximately 5000 hours under normal conditions.



**WARNING**

**Heater service should only be performed by a qualified electrician. Failure to comply can result in personal injury, death, fire and property damage.**

**Always unplug or disconnect the heater from the electrical power supply prior to any cleaning, maintenance or service work.**

ALWAYS WEAR COTTON OR OTHER FABRIC GLOVES WHEN REPLACING HEAT LAMP.  
DO NOT TOUCH THE LAMP SURFACE WITH YOUR BARE HANDS - OILS FROM YOUR SKIN WILL CAUSE DAMAGE TO THE LAMP.

The heater requires some disassembly to access electrical connections when replacing lamp.  
Use a container to securely store disassembled components and screws.

### Step 1

Compress the width of the protective screen to retract the wire tabs from under one edge of the heater body.

Rotate the loose edge of the screen up and away from heater body.

Pull the screen away from heater remove from other edge of heater body - place safety screen in secure storage.

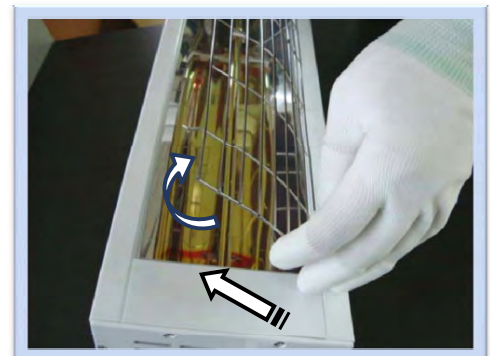

### Step 2

Remove end cover at both ends of heater.

Six (6) Phillips screws hold the end cover in place.

Remove the screws to secure storage.



### Step 3

Slide out the face plate at each end of heater to expose both ends of the heat lamp.

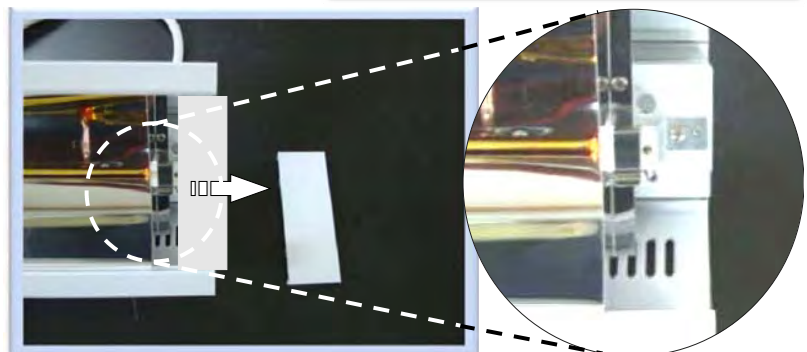

## **Heat Lamp Replacement: ... continued**

### **Step 4**

Turn heater face down, and slide the center cover plate and the heater mounting bracket out of the heater.

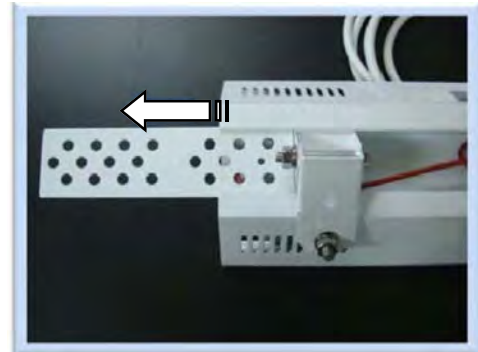

### **Step 5**

Disconnect electrical supply cord spade connectors from terminals.

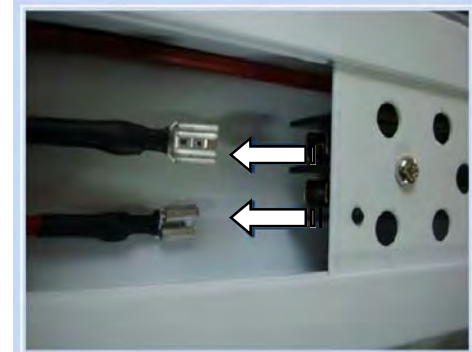

### **Step 6**

Disconnect ground wire (electrical supply cord) from the heater body by removing the anchor screw from the eye of the ground terminal.

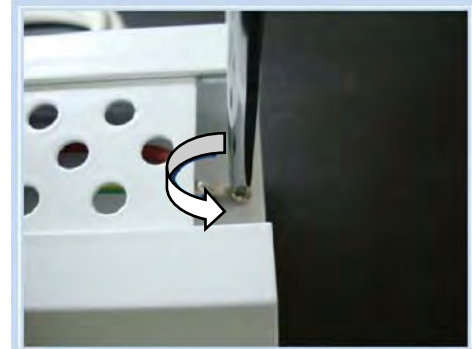

### **Step 7**

Slide power cord retainer plate from heater body.

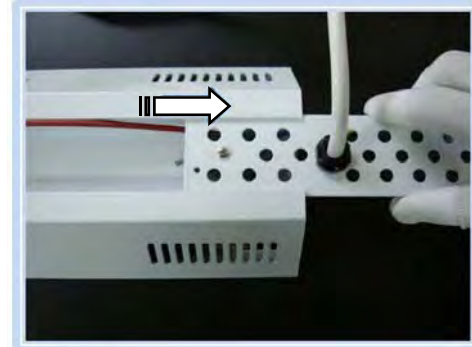



## **Heat Lamp Replacement: ... continued**

### **Step 8**

Turn heater face up.

Each end of the lamp has a rectangular retainer block.

Remove the stainless steel clips that secure the retainer blocks at each end of the lamp.

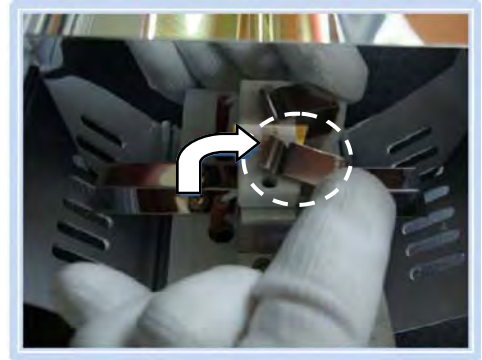

### **Step 9**

Pull the lamp wires up and out from the heater body at each end of the lamp.

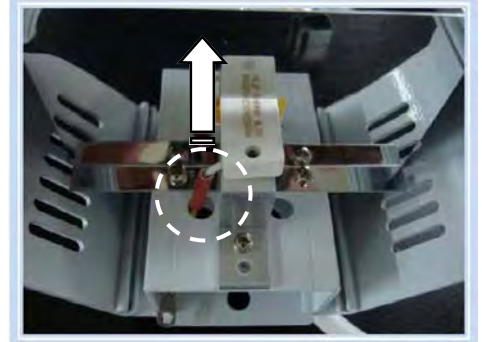

### **Step 10**

Slide the lamp out through the reflector end plate.

Properly and safely dispose of lamp.

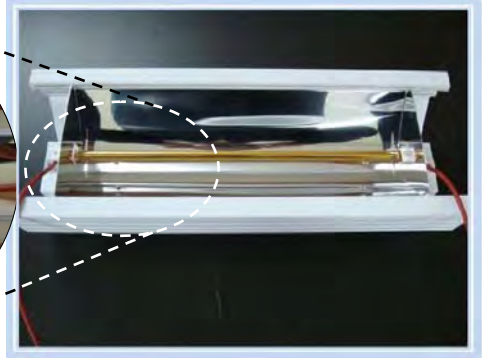
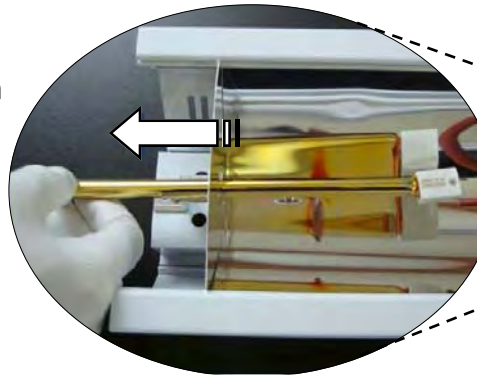

### **Step 11**

The Heat Lamp is fragile - handle with care!

Wear gloves. Do not touch lamp with bare fingers! Oils from your skin will damage the lamp.

Install the new replacement lamp and reassemble heater in reverse order of steps above.

## **InfraSave IEP SERIES HEATERS - LIMITED WARRANTY CERTIFICATE**

The Manufacturer warrants to the original consumer that this product is free from defects in material and/or workmanship under normal use and service for a period of one year (12 months) from the date of purchase, and subject to the conditions and limitations stated herein. **Warning:** Use of this heater in coastal salt-air regions can result in corrosion of the aluminum body and reflector, and premature failure of the heat lamp. Possible corrosion and failure resulting from use in coastal areas represents normal use in that environment and is not covered by warranty.

### **ONE YEAR (12 Month) WARRANTY**

Subject to the conditions and limitations stated herein and defined below, during the term of this limited warranty, we will supply any component part of the heater, excluding any labor, which the Manufacturer's examination determines to be defective in workmanship or material for a period of one year (12 months) from the date of purchase. This warranty applies to the heater's original owner, and only if the unit is installed and operated in accordance with the printed instructions accompanying the unit and in compliance with all applicable installation, building codes and good trade practices. Failure to maintain the equipment through regular maintenance or service by a qualified service technician shall void the warranty.

### **WHAT IS NOT COVERED**

The Manufacturer shall not be responsible for any expenses, including service, labor, diagnosis, analysis, material or transportation/shipping charges incurred during removal, repair, or reinstallation of this product, or any of its components or parts. All labor, shipping, and/or service charges shall be paid by the owner. This warranty does not cover products that have been modified after leaving the factory, improperly installed, misused, exposed to abuse or damaged by acts of God, negligence, accident, corrosive or contaminated atmosphere, water, excessive thermal shock, impact, abrasion, normal wear due to use, alteration or operation contrary to the owner's manual or if the serial number has been altered, defaced or removed. This warranty shall not apply if the voltage to the heater exceeds the rated voltage on the rating plate by more than 10%. The Manufacturer shall not be liable for consequential damages arising out of, or in connection with, the use or performance of the product, or other indirect damages with respect to loss of property, revenues, or profit, or costs of removal, installation or reinstallation, or for any default or delay in performance by its warranty caused by any contingency beyond its control, including war, government restrictions, or restraints, strikes, fire, flood, acts of God, or short or reduced supply of raw materials or products.

### **WARRANTY PROCEDURE**

To establish the date of purchase for any purpose under this Limited Warranty, you must retain the original receipt that can establish the purchase date of your unit. If you do not provide such documents, the start date of the term of this Limited Warranty will be based upon the date of unit manufacture, plus thirty (30) days. Do not ship a heater back to InfraSave for repair. Contact your local supplier / installer of the heater, or a local qualified electrician for warranty service or repair.

### **LIMITATIONS AND EXCLUSIONS**

This document contains all warranties made by the Manufacturer and may not be varied, altered or extended by any person. There are no promises, or agreements extending from the Manufacturer other than the statements contained herein. THIS WARRANTY IS IN LIEU OF ALL WARRANTIES EXPRESSED OR IMPLIED, TO THE EXTENT AUTHORIZED BY THE LAWS OF THE JURISDICTION, INCLUDING SPECIFICALLY THE WARRANTIES OR MERCHANTABILITY OF FITNESS FOR A PARTICULAR PURPOSE. All warranties are limited in duration to 12 months.

It is understood and agreed that the Manufacturer's obligation hereunder is limited to repairing or replacing parts determined to be defective as stated above. In no event shall the Manufacturer be responsible for any alleged personal injuries or other special, incidental or consequential damages. As to property damages, contract, tort or other claim the Manufacturer's responsibility shall not exceed the purchase price paid for the product.

All replacement parts will be warranted for the unused portion of the warranty coverage period remaining on the applicable unit.

Some States and authorities do not allow certain warranty exclusions or limitations on how long a warranty lasts or the exclusions or limitations of incidental or consequential damages. In such cases, the above limitations or exclusions may not apply to you and are not intended to do so where prohibited by law. This warranty gives you specific legal rights. You may also have other rights which vary by each jurisdiction.