



Model IEP-2024

Wall Fixed Electric Room Heater

INDOOR / OUTDOOR NON-RESIDENTIAL USE

INSTALLATION / OWNER'S MANUAL



WARNING

Read all instructions before using this heater.

Read and understand all installation and maintenance instructions thoroughly before installing or servicing this equipment.

Improper installation, operation, adjustment, alteration, service or maintenance can result in the risk of fire and electrical shock, and may cause property damage, injury or death.

SAFETY ALERT:



This heater must be serviced only by a qualified electrician. Failure to comply could result in personal injury, death, fire and/or property damage.

Do not operate this heater unless it is properly installed.

Always disconnect the heater from the power source prior to servicing.

Do not store or use gasoline or other flammable vapours and liquids in the vicinity of this or any other hot surface appliance.



Do not use or locate this model where it could fall into a bathtub or other water container.

Do not cover or block any surface of this appliance.

Do not touch this appliance while in operation

- Allow to cool after use.

Read the **IMPORTANT INFORMATION** section of this manual before using this appliance.

SAVE THESE INSTRUCTIONS

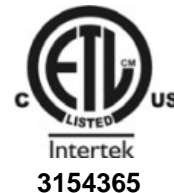

Conforms to ANSI/UL 2021
Certified to CAN/CSA C22.2 No.46

INSTALLER: PRESENT THIS MANUAL TO THE END USER. Keep this manual in a secure place.

Record the following information for future reference if service is required:

Model #: **IEP-2024**

Serial #: _____ (located on heater rating label)

NOTICE:

This contents of this manual are current for this product at the date of manufacture. Occasional revision of the product Certification Standard may require changes to the product and/or the content in the product manual. The product must be installed according to the content of this manual, and/or all local and national code requirements.

This publication is the intellectual property of Schwank. This publication, or parts thereof, may not be reproduced in any form, without prior written consent from Schwank. Unauthorized use or distribution of this publication is strictly prohibited.

Schwank Group

Schwank and InfraSave brands

5285 Bradco Boulevard

Mississauga, Ontario, L4W 2A6

2 Schwank Way

Waynesboro, Georgia 30830

Customer & Technical Services

Phone: 877-446-3727

Fax: 866-361-0523

e-mail: csr@schwankgroup.com

www.schwankgroup.com

www.infrasave.com



IEP 2024

Wall Fixed Electric Room Heater For INDOOR / OUTDOOR USE

Table of Contents

- 1. **IMPORTANT INSTRUCTIONS:**4 *Read First !!*
- 2. Heater Dimensions, Wiring, Specifications6
- 3. Project Design Guidelines.....7
- 4. Installation Instructions:
 - General Information9
 - Locating the Heater9
 - Minimum Required Clearances10
 - Heater Mounting.....10
- 5. Electrical Connection12
- 6. Operating Instructions.....12
- 7. Maintenance Instructions13
- 8. Cleaning.....13
- 9. Heater Parts.....14
- 10. Heat Lamp Replacement15
- 11. Warranty Statement.....18

- FIGURE 1: Recommended Mounting: Comfort Area Coverage8
- FIGURE 2: Minimum Required Clearances**.....10
- FIGURE 3: Mounting Bracket11
- FIGURE 4: End View & Heater Bracket.....11
- FIGURE 5: Heater Parts14



1. IMPORTANT INSTRUCTIONS

When using electrical appliances, basic precautions should always be followed to reduce the risk of fire, electric shock, injury to persons or death, and property damage including the following :

1. **Read all instructions before using this heater.**
2. **WARNING:** Risk of fire. **Do not use as a residential or household heater.**
3. **CAUTION:** HIGH TEMPERATURE - RISK OF FIRE. Keep electrical cords, and combustible materials, such as furniture, pillows, bedding, papers, clothes, and curtains at least 3 feet (36 inches) [90 cm] from the front of the heater and keep them away from the sides and rear.
4. This heater is hot when in use. To avoid burns, do not let bare skin touch hot surfaces.
5. Use this heater only when it is properly installed.
6. Extreme caution is necessary when any heater is used by or near children or infirm persons. Always supervise children and instruct and ensure that they do not play with the heater.
7. Always disconnect power source to heater when not in use. Never leave the heater unattended during operation.
8. Do not operate any heater with a damaged cord or after the heater malfunctions, has been dropped or damaged in any manner. Return heater to an authorized service facility for examination, electrical or mechanical adjustment, or repair.
9. This heater is not intended for use in bathrooms, laundry areas, and similar indoor locations. Never locate heater where it may fall into a bathtub or other water container.
10. Do not cover cord with throw rugs, clothing, or the like.
11. Arrange the cord at the side and back of the heater - do not allow cord to drape over the heater.
12. To disconnect heater, turn controls to 'off', or switch off at power source.
13. Only connect the heater to a 240Vac copper wire circuit that is properly grounded.
14. Do not insert or allow foreign objects to enter the heater or any ventilation or exhaust opening as this may cause an electric shock, fire, or damage the heater - death, personal injury or property damage could result.

continued ...



IMPORTANT INSTRUCTIONS *continued*



15. To prevent a possible fire, do not block air intakes or exhaust in any manner. Do not use on a soft surface, like a bed, where openings may become blocked.



16. To reduce the risk of fire - Do not store or use gasoline, paint, or other flammable liquids or vapors in the vicinity of the heater.

17. Use this heater only as described in this manual. Any other use not recommended by the manufacturer may cause fire, electric shock, and death or injury to persons and property damage.

18. Do not touch an operating heater or live parts - burns, electric shock and death or personal injury can result.

19. Do not adjust the heater on the swivel bracket during operation. Allow heater to cool before making any adjustment to heater position.

20. Do not stare at the heater Lamp - damage to your eyes could occur.



21. After use, allow the heater to cool down before touching, moving, or storing.

22. These instructions belong with the heater for ready reference. Keep this manual in a safe place near the heater.

23. **“SAVE THESE INSTRUCTIONS”**

2. HEATER DIMENSIONS, WIRING, SPECIFICATIONS - IEP 2024

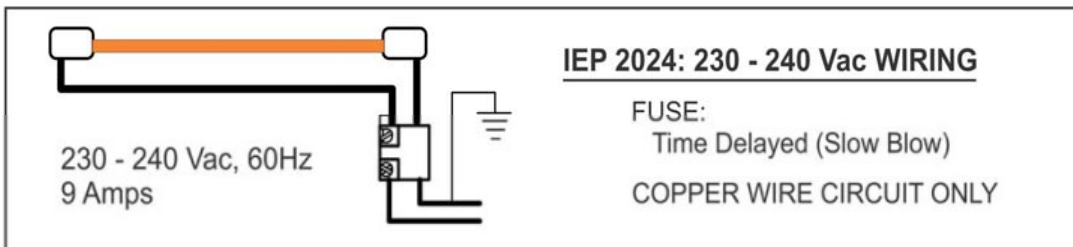
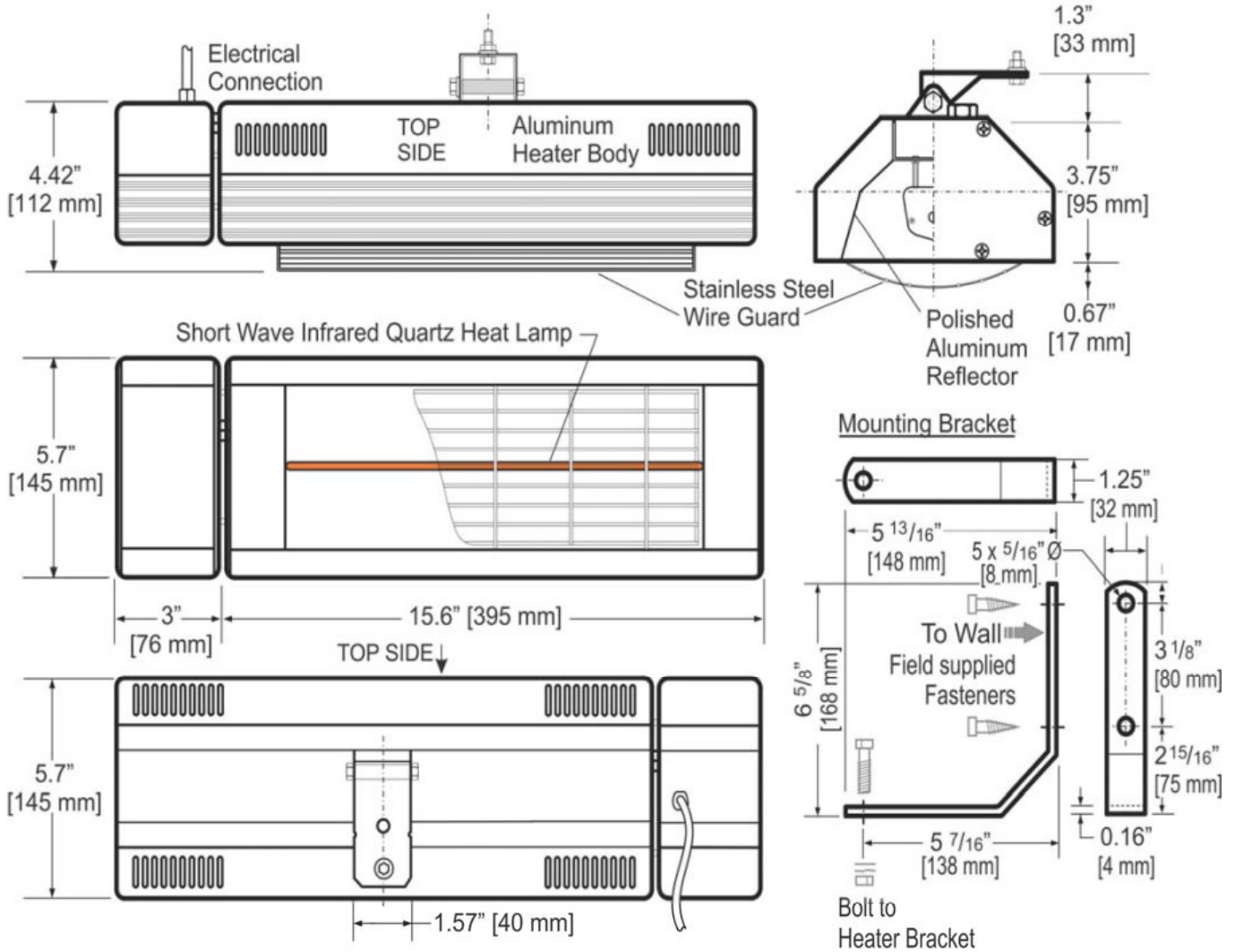

<p>IEP 2024 Outdoor / Indoor Use</p> <p>SPECIFICATIONS</p> <ol style="list-style-type: none"> 1) Voltage : 230 - 240Vac, 60Hz, 9 Amps 2) Wattage : 2000 W 3) Lamp Temperature: 2420°F [1325°C] ±360°F [200°C] 4) Total Weight: 5 lbs (2.2 kg) 	<p>OPERATING CONDITIONS</p> <ol style="list-style-type: none"> 1) Operating Position: <ul style="list-style-type: none"> Long Axis: Horizontal Short Axis: Horizontal to 45° 2) 'On' Cycle: Continuous or Intermittent <p>LAMP LIFE</p> <ol style="list-style-type: none"> 1) 5,000 Hours (Normal Conditions)
---	---

3. PROJECT DESIGN GUIDELINES:

NOTE: Also refer to Section 4. Installation, and Table 2 and Figure 2 regarding the Minimum Required Clearances.

The size and quantity of heaters (amount of heat input) required over an area to provide comfort is affected by the following factors:

- General:
 - Amount of air movement in the area: “wind chill” requires additional heat input
 - Provide wind breaks wherever possible
 - ‘Spot heating’ comfort is most effective if people are heated from at least two sides
 - Available mounting height for heaters at the project site
- Indoor application:
 - ‘Space heat’ the entire structure¹ (accurate heat loss calculation required), or
 - ‘Spot heat’ only part of a cold indoor area
 - The activity level of the people: seated at rest, hard physical labor, etc.
- Outdoor application: *Any area heated outdoors is ‘Spot heat’*
 - NOTE: Model IEP 2024 is for INDOOR or OUTDOOR NON-RESIDENTIAL use
 - Ensure that the heater model is suitable and approved for outdoor use
- Desired temperature rise:
 - What seasons is comfort required and what is the outside design temperature?
 - Then what comfort temperature rise is desired? (10°, 15°, 20°, 25°?)
- Calculate the required input to get the desired average temperature rise:

Input Required per Area per Degree Comfort Temperature Rise

	Heat Density per Degree F $\frac{w}{(ft^2)/F^\circ}$	Heat Density per Degree C $\frac{w}{(m^2)/C^\circ}$
Outdoor Heating	2	40
Indoor Spot Heat	0.75	14

- Input = Site Length x Site Width x Temperature Rise x Heat Density per Degree
- Example:
 - Outdoor Patio: 30 ft long by 10 feet wide
 - Desired temperature rise: 20°F (*average over the area*)
 - 30 x 10 x 20 x 2 = 12,000 Watts total input required
- Compare the values of the available mounting height and area dimensions at the project site to the recommended mounting heights, length and width of coverage area, and typical average heat distribution in Figure 1 & Table 1 (next page)
- Layout:
 - Space the heaters uniformly around the perimeter (and if required, in the center or throughout the area) to provide sufficient heat density to accomplish the desired temperature rise or spot heat only specific locations within the area
 - Provide heat from at least two sides wherever possible

¹ Contact Schwank Design Services for assistance at design@schwankgroup.com.

The design information presented here is intended as a guideline. The accuracy of determining or estimating all factors above will affect performance and satisfaction. Air movement in particular will affect comfort.

FIGURE 1: RECOMMENDED MOUNTING: COMFORT AREA COVERAGE

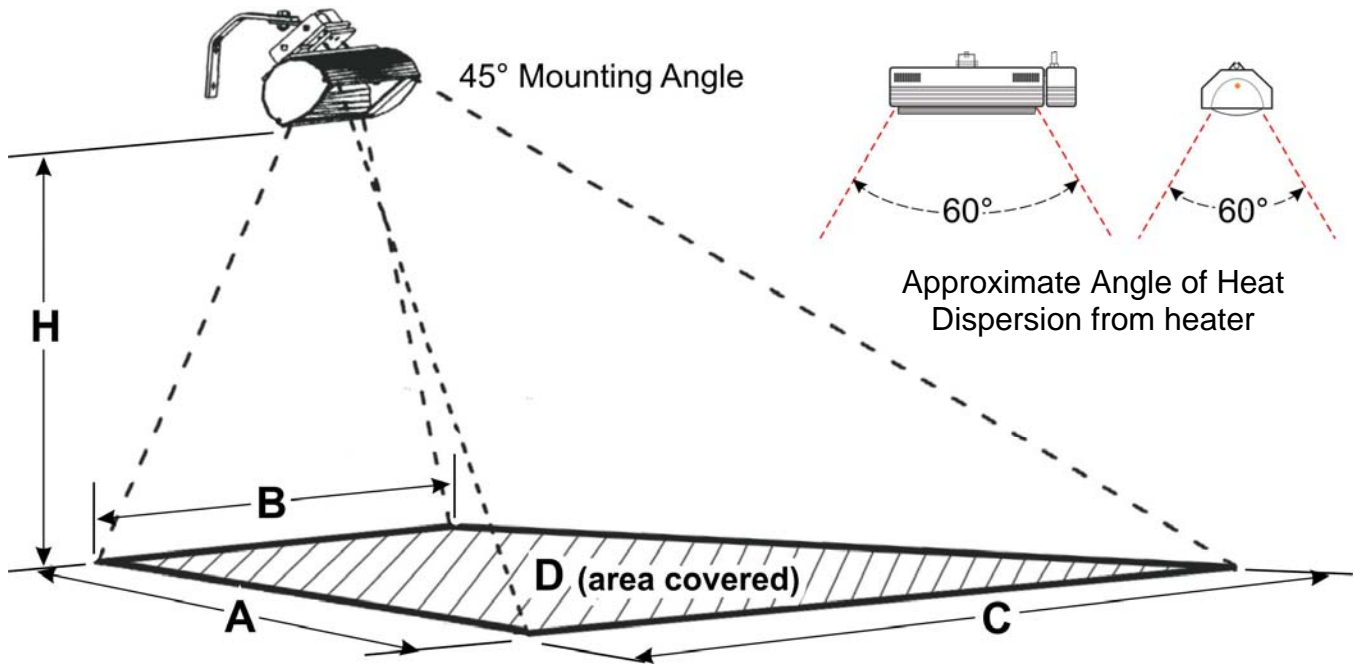

TABLE 1: RECOMMENDED MOUNTING: COMFORT AREA COVERAGE

Model	Input Watts	Recommended Min / Max	H Height Above Floor/Deck ft [m]	A Distance Out ft [m]	B Under Heater ft [m]	C Outer Perimeter ft [m]	D Area Heated ft ² [m ²]	E Average Heat Coverage watts / ft ²
IEP 1520/4	1500	Min.	7 [2.1]	8.8 [2.7]	8.5 [2.6]	16 [4.9]	108 [10.1]	13.9
		Max.	8 [2.4]	9.8 [3.0]	9.2 [2.8]	18 [5.5]	133 [12.4]	11.3
IEP 2024	2000	Min.	8 [2.4]	9.8 [3.0]	9.2 [2.8]	18 [5.5]	133 [12.4]	15.0
		Max.	9 [2.7]	11 [3.4]	10 [3.0]	20 [6.1]	165 [15.3]	12.1
IEP 4024	4000	Min.	10 [3.0]	12 [3.6]	11.2 [3.4]	23 [7.0]	205 [19.0]	19.5
		Max.	11.5 [3.5]	13.5 [4.1]	14 [4.3]	27.5 [8.4]	275 [25.4]	14.5
IEP 6024	6000	Min.	12 [3.7]	14 [4.3]	15 [4.6]	29.5 [9.0]	315 [29.2]	19.0
		Max.	15 [4.6]	14.4 [4.4]	17.7 [5.4]	32 [9.8]	360 [33.4]	16.7

- Refer to design guidelines on previous page.
- Refer to Required Minimum Clearances: Table 2 & Figure 2, Page 10

4. INSTALLATION INSTRUCTIONS

General: READ ALL INSTRUCTIONS AND PLAN THE INSTALLATION BEFORE PROCEEDING

This appliance conforms to ANSI/UL 2021 and is certified to CAN/CSA C22.2 No.46. This appliance is approved for outdoor and indoor non-residential use. Do not use this heater in environments such as bathrooms and laundry rooms.

The heater must connect to a properly grounded 230 - 240Vac outlet on a copper wire electrical supply circuit. Installation must conform with the latest edition Electrical Code ANSI/NFPA N0 70 in the U.S.A. and PART 1 CSA C22.1 in Canada.

A mounting bracket is supplied with the heater, and can be mounted to a wall or post. The heater must be mounted to this bracket during operation. Hardware to fasten the mounting bracket to the structure is determined by site conditions, and is field supplied by the installer.



IMPORTANT: Always maintain the minimum clearances from the floor, ceiling, side walls, and combustible materials. Refer to Table 2 and Figure 2 next page.

Locating the Heater:

Warning: Use of this heater in coastal salt-air regions can result in corrosion of the aluminum body and reflector, and premature failure the heat lamp. Corrosion and failure resulting from use in coastal areas represents normal use in that environment and is not covered by warranty.

1. The heater is designed for wall or post mounting and must be installed at least 6 feet (1.8 m) above the floor.
2. Ensure that clearances from the heater meet or exceed the minimum required clearances in Table 2, and Figure 2 below: Above; to the Floor; to a Side wall; and to Combustible materials.
3. The heater must be connected to a properly grounded 230 - 240Vac copper wire circuit.
4. The heater should never be placed nor mounted directly under a wall electrical outlet.
5. A minimum distance of 3 ft (36 inches) [90 cm] must be maintained between the front grille and flammable items (e.g. curtains), walls and other structures.
6. Do not allow an electrical cord to pass in front of the heater or to touch any hot surface.
7. The appliance must not be mounted directly on flammable materials (no wood or similar).
8. Since the appliance radiates heat, no obstruction or object such as furniture should be placed between the heater and the person being heated.
9. Do not use heater on a soft surface, like a bed, where air openings may become blocked.
10. A heater has hot surfaces and potentially arcing or sparking parts inside. Do not use in areas where gasoline, paint, or flammable vapors or liquids are used or stored.

TABLE 2: MINIMUM REQUIRED CLEARANCES

IEP 2024	Above 'A' Inches [cm]	Floor 'F' Inches [cm]	Clearance 'C' Inches [cm]	Spacing 'D' Inches [cm]
2000 W, 230 - 240V, 60 Hz 9 Amps	12" [30]	72" [180]	36" [90]	More than 36" [90]

FIGURE 2: MINIMUM Required Clearances

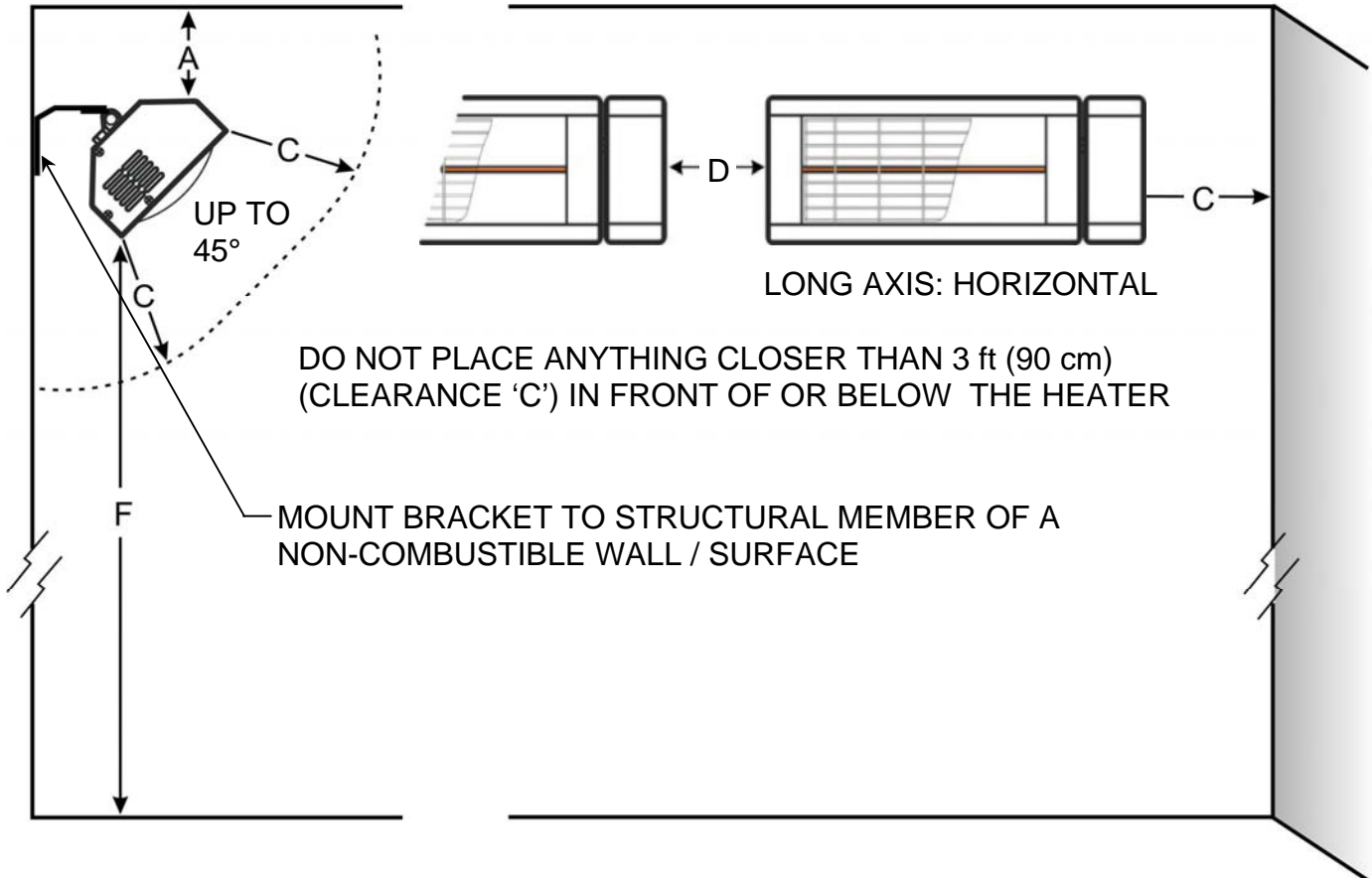

Heater Mounting:

1. Mount the heater on a non-combustible surface or structural member, and maintain at least all minimum clearances indicated in Table 2 and Figure 2 above.
2. Use the Mounting Bracket supplied with the heater - see Figure 3 next page.
3. Hardware to fasten the Mounting Bracket to the structure is field supplied by the installer since the type of hardware fastening is determined by site conditions.
4. Connect heater to a 230 - 240 Vac, 60Hz, 9 Amp copper wire circuit that is properly grounded. Electrical connection must be performed by a qualified electrical tradesperson. Installation must conform with the latest edition Electrical Code ANSI/NFPA N0 70 in the U.S.A. and PART 1 CSA C22.1 in Canada.
5. Never allow an electrical cord to pass in front of the heater or to come into contact with any hot surface of the heater.

continued ...

FIGURE 3: MOUNTING BRACKET

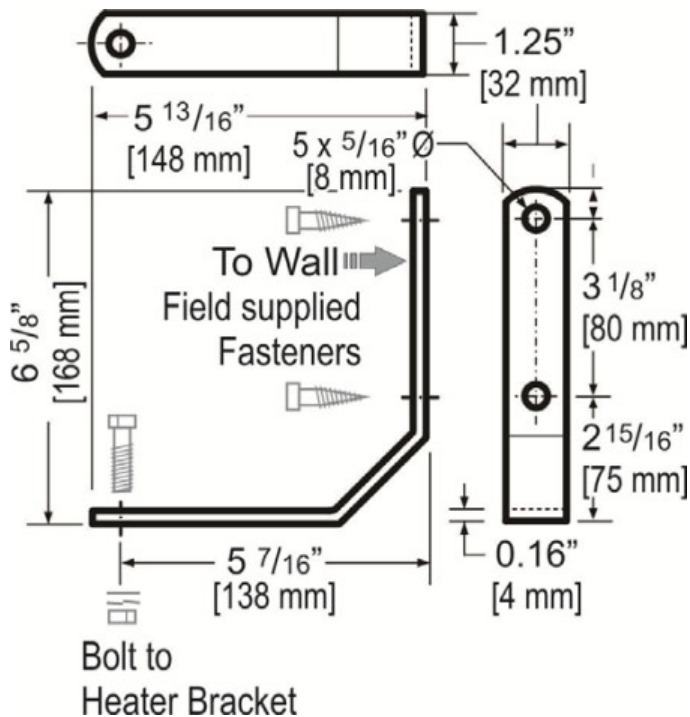

**FIGURE 4:
END VIEW WITH
HEATER BRACKET**

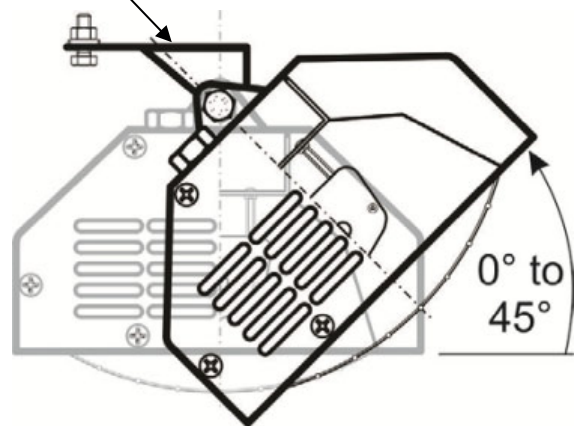

6. The Mounting Bracket fastens to the structure using field supplied bolts or lag screws through two holes in one side of the bracket. The heater bracket fastens to the Mounting Bracket through the outermost hole on the other leg of the Mounting Bracket, using the bolt, lock washer and nut supplied.
7. Fasten the Mounting Bracket 'plumb' and level so that the heater is oriented horizontally on the long axis.
8. Ensure that the mounting bracket is firmly fastened to the structure with bolts or lag screws (field supplied) of sufficient strength and integrity to support the weight and prevent movement of the heater. It is recommended to fasten the mounting bracket to a structural member (wall stud, etc.).
9. Attach the heater bracket to the Mounting Bracket (outermost hole), using the bolt, lock washer and nut supplied - tighten securely.
10. The bracket attached to the top of the heater allows rotation up to 45° on the short axis by loosening the attachment bolt.
11. Once heater position is established, tighten all nuts and bolts at mounting and heater bracket connections to maintain the heater in a secure and stable position.
12. Read and follow all warnings, and the following section on Operation to enjoy safe operation of the heater.

5. ELECTRICAL CONNECTION

Connect heater to a 230 - 240 Vac, 60Hz, 9 Amp copper wire circuit that is properly grounded. Electrical connection must be performed by a qualified electrical tradesperson. Installation must conform with the latest edition Electrical Code ANSI/NFPA N0 70 in the U.S.A. and PART 1 CSA C22.1 in Canada.

6. OPERATING INSTRUCTIONS

1. The heater must be properly installed prior to use.
2. Always ensure the heater is located at a safe distance from the floor, ceiling, side walls, and combustible materials - refer to Table 2 and Figure 2.
3. Maintain a minimum distance of 36 inches [90 cm] from heater to combustible material.
4. Always be aware and careful of the risk of fire and electric shock.
5. The power cord must not come into contact with hot appliance parts or surfaces and must not pass in front of the heater.
6. Do not crush the cord, nor drag it over sharp edges, nor place it over a heated hotplate or open flame.
7. Read, understand, and explain and describe to other users the location, function, and operation of each control of the heater, including all user-operated devices intended to reduce the risk of fire, electric shock, or injury to persons and warn against tampering with such.
8. The heater must only be connected to a 230 - 240Vac, 60 Hz, 9 amp grounded copper wire circuit outlet. A time delayed fuse may be necessary for circuit protection.
9. If the supply cord is damaged, it must be replaced by a qualified electrician in order to avoid a hazard.
10. High heat is generated from the front of the heater.
11. Do not allow children to touch or play with the heater.
12. Do not use the heater to dry wet materials or clothing.

7. MAINTENANCE INSTRUCTIONS



WARNING

Heater service should only be performed by a qualified electrician. Failure to comply could result in personal injury, death, fire and/or property damage.

Tampering with the heater by an unqualified person will void the warranty.



WARNING

Always disconnect the heater from the electrical power supply prior to any cleaning, maintenance or service work.

Never immerse the appliance in water! Danger to life!



CAUTION: The Heat Lamp is fragile. Handle the heater with care so as not to damage the Heat Lamp. Never touch the Lamp with bare fingers. Oils from your skin will damage the Lamp.

Inspect the heater prior to each use:

- Clean any accumulation of dust or dirt from surfaces and in particular from the reflector and any air openings in the heater body (refer to Cleaning section below).
- Any damaged parts or components must be repaired or replaced prior to operation.

Service and Repair:

- Disconnect the heater from the power source prior to any servicing
- Important: All repairs must be referred to qualified electrician!
- Repairs carried out improperly or by an unqualified person may have serious consequences for the user!
- Any tampering with the appliance will invalidate the warranty.

8. CLEANING

- Before cleaning - Disconnect the heater from the power supply and allow to cool.
- Do not touch the Heat Lamp with your fingers - oil from your skin will damage the Lamp.
- To clean the heater surface, reflector, and air inlets: Use only a dry or damp cloth or low pressure air stream (computer 'duster' in a can).
- Do not use any abrasive or caustic cleaning agents.
- Never immerse the appliance in water! Danger to life!
- If a heater is exposed to water have a qualified electrician inspect and repair the heater prior to use.
- Inspect the electrical cord for damage or fraying.
 - Do not operate the heater with a damaged cord
 - Have damaged parts replaced by a qualified electrician

9. HEATER PARTS - IEP 2024

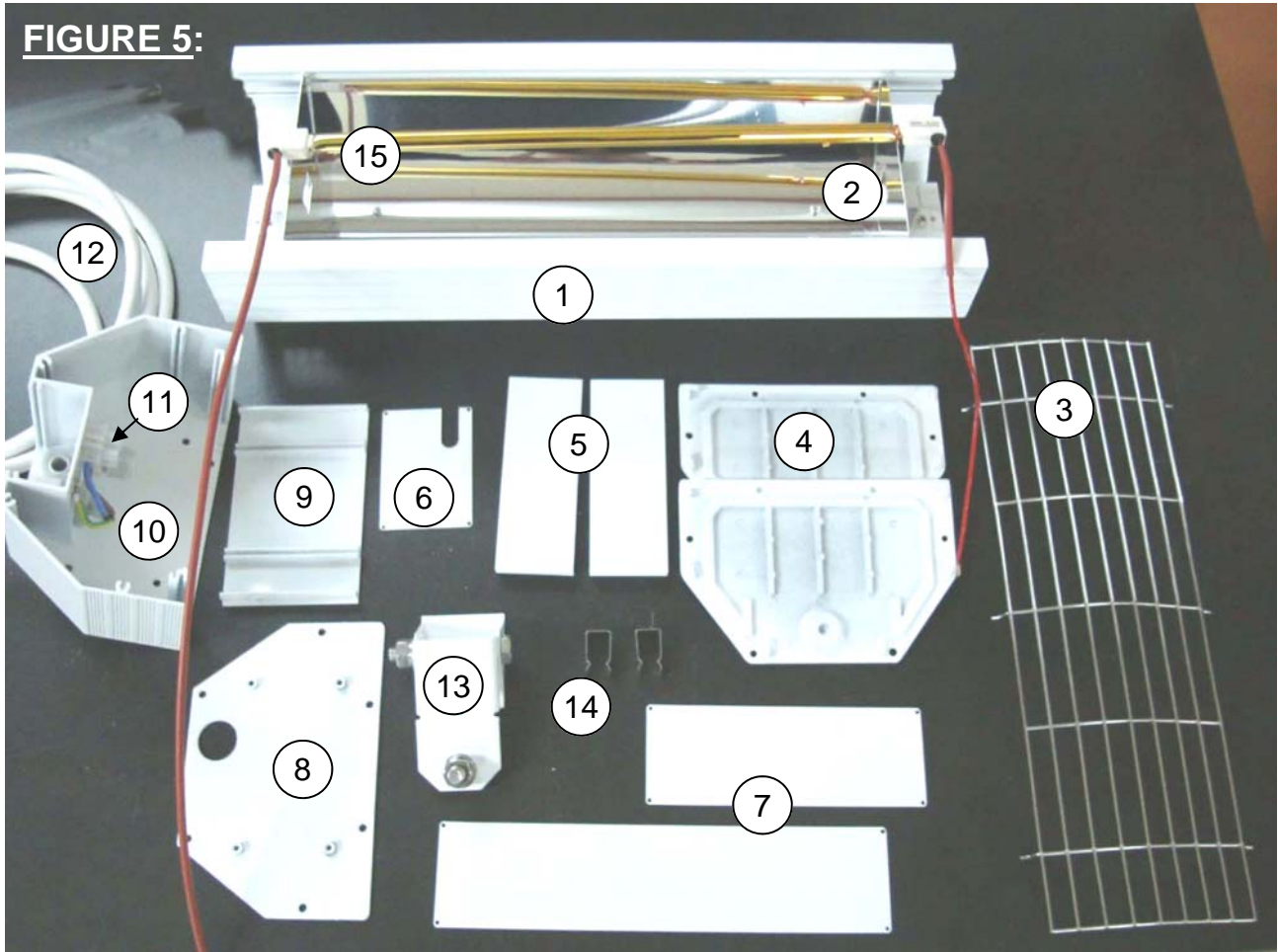

FIGURE 5:



1. Heater Body - cast aluminum
2. Polished Aluminum Reflector Assembly
3. Protective Screen
4. End Covers
5. Heater Face Plates
6. Power Cord Retainer Plate
7. Center Cover Plates (top side)
8. Connection Box Cover
9. Connection Box Face Plate
10. Connection Box
11. Terminal Block for electrical connections
12. Power Cord
13. Heater Mounting Bracket
14. Lamp Retainer Clips
15. Heat Lamp - 2000 Watts - Part # JE-

10. HEAT LAMP REPLACEMENT

The Heat Lamp will operate for approximately 5000 hours under normal conditions.

	WARNING Heater service should only be performed by a qualified electrician. Failure to comply can result in personal injury, death, fire and property damage.
	IMPORTANT ALWAYS DISCONNECT THE HEATER FROM THE ELECTRICAL POWER SUPPLY PRIOR TO CLEANING, MAINTENANCE, LAMP CHANGE, OR SERVICE.

ALWAYS WEAR COTTON OR OTHER FABRIC GLOVES WHEN REPLACING HEAT LAMP. DO NOT TOUCH THE LAMP SURFACE WITH YOUR BARE HANDS - OILS FROM YOUR SKIN WILL CAUSE DAMAGE TO THE LAMP.

The heater requires disassembly to replace the heat lamp.

Use a container to securely store disassembled components and screws.

Step 1

Compress the width of the protective screen to retract the wire tabs from under one edge of the heater body.

Rotate the loose edge of the screen up and away from heater body.

Pull the screen away from heater to remove from other edge of heater body - place safety screen in secure storage.

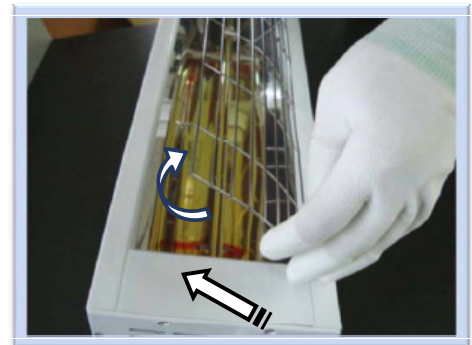

Step 2

Remove connection box end cover .

Six (6) Phillips screws hold the end cover in place.

Remove the screws and end cover to secure storage.

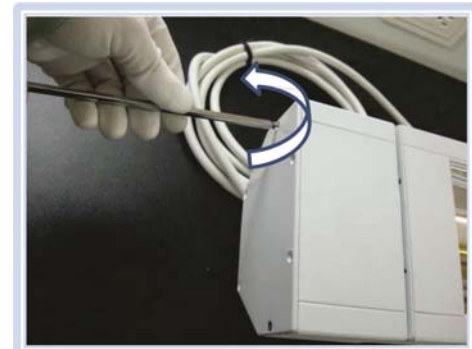

Step 3

Remove 4 Phillips screws that hold connection box to heater.

Slide out the face plate at each end of heater to expose both ends of the heat lamp.

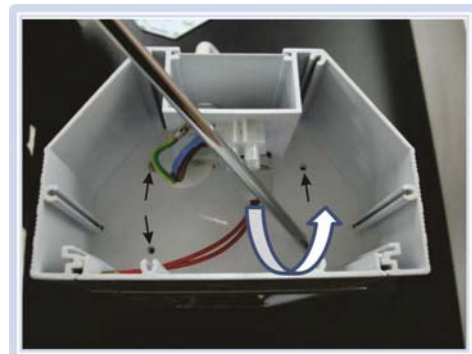

Heat Lamp Replacement: ... continued

Step 4

Remove 2 Phillips screws that fasten the electrical connection box front face plate in place.

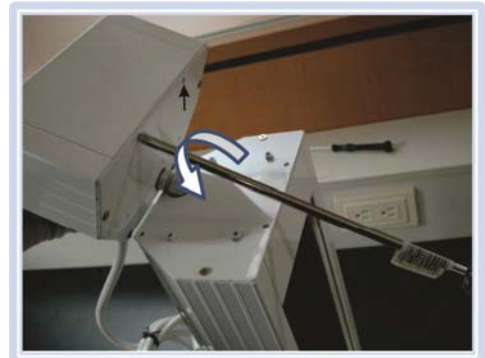

Step 5

Slide the electrical connection box front face plate out from the electrical connection box.

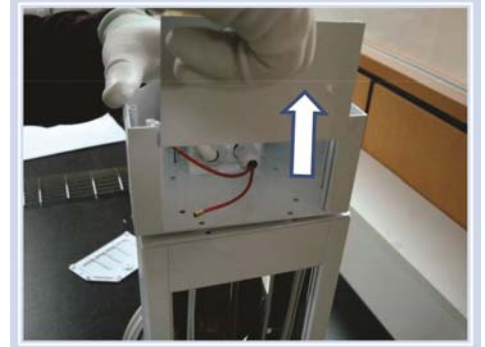

Step 6

Loosen 2 screws in terminal block that connect the red heat lamp wires in place. Remove ends of red wires from terminal block.

6A - Loosen plastic collar on Liquid Tight Connector that secures red wires to connection box.

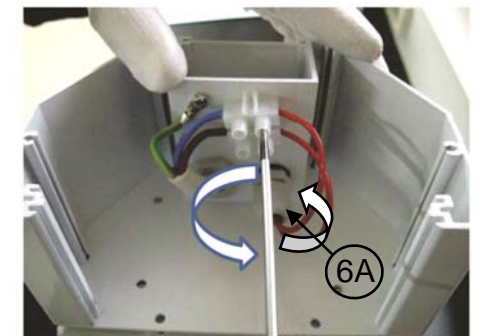

Step 7

Slide power cord retainer plate from heater body (top surface of heater).

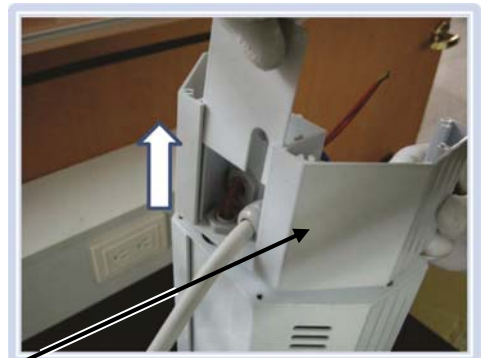

Step 8

Loosen plastic collar on second Liquid Tight Connector that secures red wires through connection box end plate.

Slide red wires out of connection box.
Set connection box aside.

Connection
Box

Heater
Body



Heat Lamp Replacement: ... continued

Step 9

Remove end plate from heater: 6 Phillips screws fasten the heater body end plate in place.

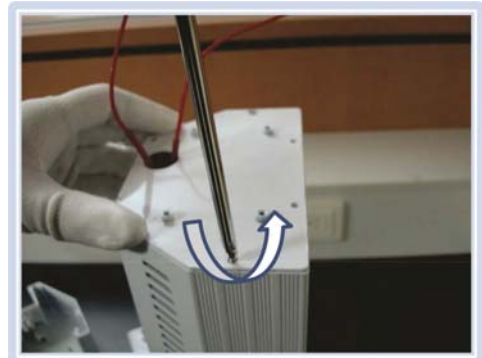

Step 10

Slide cover plates and heater mounting bracket out from top side of heater.

Remove remaining end plate from other end of heater.



Step 11

Slide Face Plate out from each end of heater.

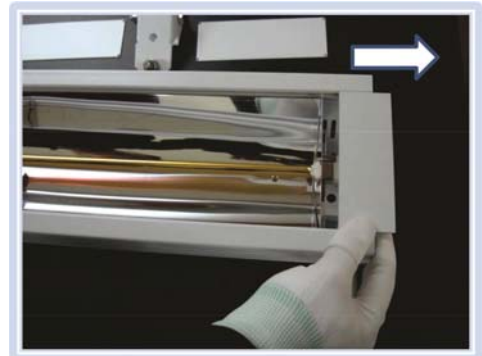

Step 12

Remove the heat lamp retainer clip at each end of lamp.

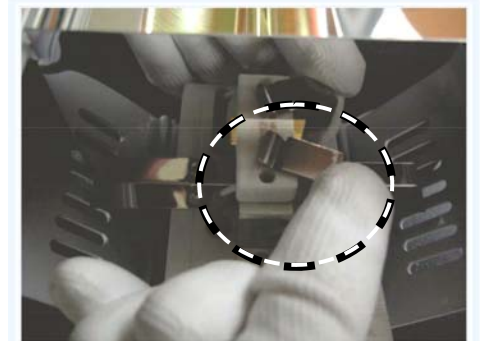

Step 13

IMPORTANT: Wear gloves to handle the heat lamp.
Oils from your skin will damage the lamp.

The heat lamp is fragile! Carefully slide old heat lamp out of heater through rectangular slot in end of reflector.

Carefully install new heat lamp and clip in place.

Reverse steps above to reassemble the heater.

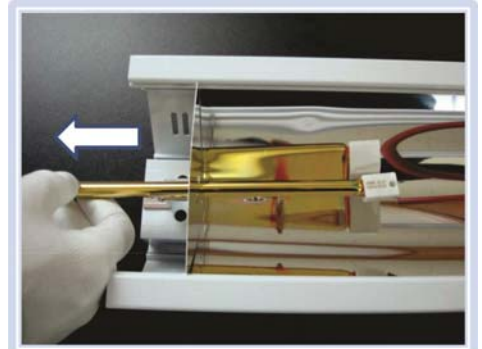

InfraSave IEP SERIES HEATERS - LIMITED WARRANTY CERTIFICATE

The Manufacturer warrants to the original consumer that this product is free from defects in material and/or workmanship under normal use and service for a period of one year (12 months) from the date of purchase, and subject to the conditions and limitations stated herein. **Warning:** Use of this heater in coastal salt-air regions can result in corrosion of the aluminum body and reflector, and premature failure of the heat lamp. Corrosion and failure resulting from use in coastal areas represents normal use in that environment and is not covered by warranty.

ONE YEAR (12 Month) WARRANTY

Subject to the conditions and limitations stated herein and defined below, during the term of this limited warranty, we will supply any component part of the heater, excluding any labor, which the Manufacturer's examination determines to be defective in workmanship or material for a period of one year (12 months) from the date of purchase. This warranty applies to the heater's original owner, and only if the unit is installed and operated in accordance with the printed instructions accompanying the unit and in compliance with all applicable installation, building codes and good trade practices. Failure to maintain the equipment through regular maintenance or service by a qualified service technician shall void the warranty.

WHAT IS NOT COVERED

The Manufacturer shall not be responsible for any expenses, including service, labor, diagnosis, analysis, material or transportation/shipping charges incurred during removal, repair, or reinstallation of this product, or any of its components or parts. All labor, shipping, and/or service charges shall be paid by the owner. This warranty does not cover products that have been modified after leaving the factory, improperly installed, misused, exposed to abuse or damaged by acts of God, negligence, accident, corrosive or contaminated atmosphere, submersion in water, excessive thermal shock, impact, abrasion, normal wear due to use, alteration or operation contrary to the owner's manual or if the serial number has been altered, defaced or removed. This warranty shall not apply if the voltage to the heater exceeds the rated voltage on the rating plate by more than 10%. The Manufacturer shall not be liable for consequential damages arising out of, or in connection with, the use or performance of the product, or other indirect damages with respect to loss of property, revenues, or profit, or costs of removal, installation or reinstallation, or for any default or delay in performance by its warranty caused by any contingency beyond its control, including war, government restrictions, or restraints, strikes, fire, flood, acts of God, or short or reduced supply of raw materials or products.

WARRANTY PROCEDURE

To establish the date of purchase for any purpose under this Limited Warranty, you must retain the original receipt that can establish the purchase date of your unit. If you do not provide such documents, the start date of the term of this Limited Warranty will be based upon the date of unit manufacture, plus thirty (30) days. Do not ship a heater back to InfraSave for repair. Contact your local supplier / installer of the heater, or a local qualified electrician for warranty service or repair.

LIMITATIONS AND EXCLUSIONS

This document contains all warranties made by the Manufacturer and may not be varied, altered or extended by any person. There are no promises, or agreements extending from the Manufacturer other than the statements contained herein. THIS WARRANTY IS IN LIEU OF ALL WARRANTIES EXPRESSED OR IMPLIED, TO THE EXTENT AUTHORIZED BY THE LAWS OF THE JURISDICTION, INCLUDING SPECIFICALLY THE WARRANTIES OR MERCHANTABILITY OF FITNESS FOR A PARTICULAR PURPOSE. All warranties are limited in duration to 12 months.

It is understood and agreed that the Manufacturer's obligation hereunder is limited to repairing or replacing parts determined to be defective as stated above. In no event shall the Manufacturer be responsible for any alleged personal injuries or other special, incidental or consequential damages. As to property damages, contract, tort or other claim the Manufacturer's responsibility shall not exceed the purchase price paid for the product.

All replacement parts will be warranted for the unused portion of the warranty coverage period remaining on the applicable unit.

Some States and authorities do not allow certain warranty exclusions or limitations on how long a warranty lasts or the exclusions or limitations of incidental or consequential damages. In such cases, the above limitations or exclusions may not apply to you and are not intended to do so where prohibited by law. This warranty gives you specific legal rights. You may also have other rights which vary by each jurisdiction.